

DIN Topf Schmutzfänger | T Basket Strainer

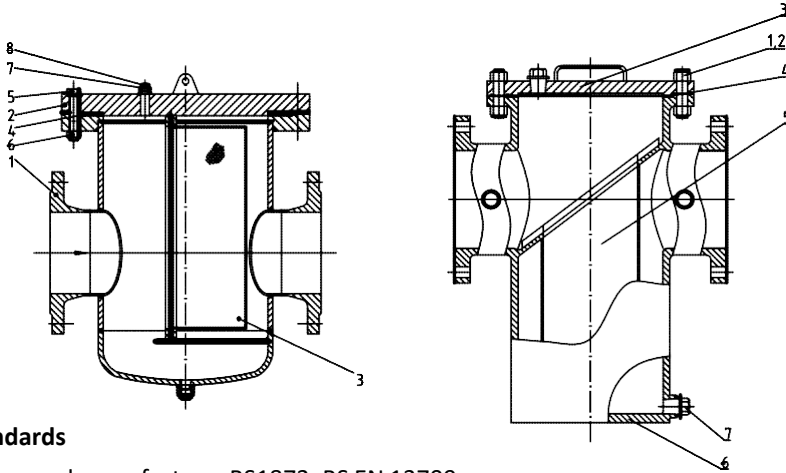

Standards

Design and manufacture: BS1873, BS EN 13709

Face to Face Dimensions: DIN3202, BS EN 558-1

Flange Ends Dimensions; DIN2543-2551, BS EN 1092-1

Test & Inspect: DIN EN 10204-3.1 , EN 12266-1

Percentage open area

Even the mesh" is same:

Open area not always same

due to the diameter of wire.

The details of wire as follows:

A: Number of Wire

B: Diameter of Wire

C: Width of Opening

D: Percentage of OPEN AREA

MSEH	A AWG	B m/m	C m/m	D %
5	20	0.914	4.166	67.3
10	22	0.711	1.829	51.8
20	28	0.356	0.914	51.8
30	32	0.274	0.572	45.7
40	36	0.193	0.442	48.4
50	37	0.172	0.336	43.6
60	38	0.152	0.271	41.0
80	40	0.122	0.195	37.8
100	42	0.102	0.152	35.8
120	43	0.092	0.119	31.8
150	45½	0.066	0.103	37.1
180	46½	0.053	0.088	38.9
200	47	0.051	0.076	35.8
250	48	0.040	0.062	37.7
300	48	0.039	0.044	27.6

Parts and material list

Part Name		Material		
1	Body	1.0619 / A216 WCB	DIN 17445 1.4308	DIN 17445 1.4408
2	Screen	ASTM 182 F304	ASTM 182 F304	ASTM 182 F316
3	Bonnet bolt	ASTM 193 B7	ASTM 193 B8	ASTM 193 B8
4	Bonnet Nut	ASTM 194 2H	ASTM 194 8	ASTM 194 8
5	Gasket	Graphite+SS304	Graphite+SS304	Graphite+SS316
6	Bonnet	1.0619 / A216 WCB	DIN 17445 1.4308	DIN 17445 1.4408

Dimensions																			
PN25 (DIN 3203-F1)																			
DN	mm	15	20	25	32	40	50	65	80	100	125	150	200	250	300	350	400	500	600
L	mm	130	150	160	180	200	230	290	310	350	400	480	600	730	850	980	110	1250	1450
H	mm	98	103	108	115	140	150	175	205	245	285	335	415	490	570	580	618	730	890

Die oben angegeben Werkstoffe können auch gemäß Kundenwunsch angepasst werden. Hierzu wenden Sie sich bitte an unsere technische Abteilung. Änderungen vorbehalten!