

Forged steel check valves

Häger valves are available in Three bonnet designs. The first design is the Bolted Bonnet, with male-female joint, spiral wound gasket, made in F304L/graphite. Ring joint gasket are also available on request. The second design is the welded bonnet, with a threaded and seal welded joint. On request a full penetration strength welded joint is available. The third design is the pressure seal bonnet, with a threaded and pressure seal bonnet joint. The check valves are also available in three different design configurations. These are piston check, ball check, or swing check designs.

Construction is as follows

- ※ Full port or conventional port;
- ※ Lift type check valves;
- ※ Ball type check valves;
- ※ Swing type check valves;
- ※ According to requirement equip inside spring;
- ※ Bolted bonnet with spiral-wound gasket, threaded and seal welded bonnet or threaded and pressure seal bonnet;
- ※ Socket weld ends to ASME B16.11;
- ※ Screwed ends (NPT) to ANSI/ASME B1.20.1;
- ※ Disc can change for soft seal disc and ball disc.



Female threaded and socket welded check valves

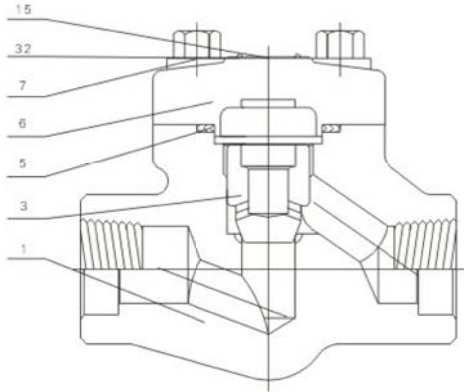

Please mark in you offer if you need load spring

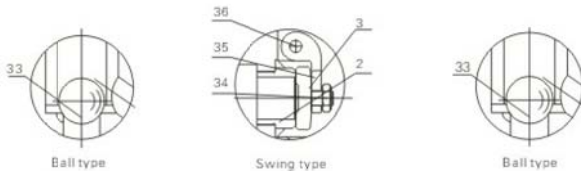

Application standards

- 1、 Design and manufacture conform to BS5352 MSS SP-118;
- 2、 Connection ends conform to:
 - 1)Socket welded ends conform to ANSI B16.11;JB/T1751
 - 2)Screw ends conform to ANSI B1.20.1;JB/T7306
 - 3)Butt-welded ends conform to ANSI B16.25;JB/T12224
 - 4)Flanged ends conform to ANSI B16.5;JB79
- 3、 Test and inspection conform to: API 598; GB/T13927; JB/T9092
- 4、 Structure features: Bolted bonnet、 Welded bonnet
- 5、 Materials conform to ANSI/ASTM.
- 6、 Main materials: A105; LF2; F5; F11; F22; 304(L); 316(L); F347; F321; F51; Monel; 20 Alloy.

Carbon steel temperature–pressure rate

CL150–285 P.S.I @ 100° F
 CL300–740 P.S.I @ 100° F
 CL600–1480 P.S.I @ 100° F
 CL800–1975 P.S.I @ 100° F
 CL1500–3705 P.S.I @ 100° F

Main part materials list

NO.	Part name	A105/F6a	A105/F6aHFS	LF2/304	F11/F6aHF	F304(L)/304(L)	F316(L)/316(L)	F51/F51
1	Body	A105	A105+HF	LF2	F11+HF	F304(L)	F316(L)	F51
		A105	A105	LF2	F11	F304(L)	F316(L)	F51
2	Seat ring	410	410HF	304	410HF	304(L)	316(L)	F51
3	Disc	F6a	F6a	F304	F6aHF	F304(L)	F316(L)	F51
5	Gasket	304+ Flexible graphite	304+ Flexible graphite	304+ Flexible graphite	304+ Flexible graphite	304+ Flexible graphite	316+ Flexible graphite	316+ Flexible graphite
6	Bonnet	A105	A105	LF2	F11	F304(L)	F316(L)	F51
7	Bolt	B7	B7	L7	B16	B8(M)	B8(M)	B8M
15	Nameplate	AL	AL	AL	AL	AL	AL	AL
32	Revit	AL	AL	AL	AL	AL	AL	AL
33	Steel ball	430	430	304	STL	316(L)	316(L)	STL
		304	304	304	304	304(L)	316(L)	F51
34	Disc nut	2H	2H	8	8	8(M)	8(M)	8M
35	Hinge	410	410	304	410	316(L)	316(L)	F51
36	Pin	410	410	304	410	304(L)	316(L)	F51

Female threaded and socket welded check valves

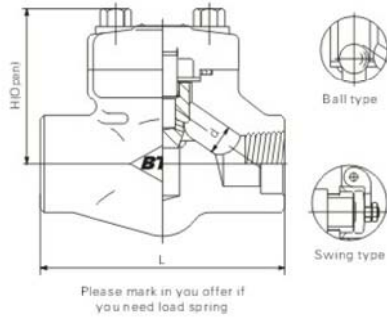

CL800 Bolted bonnet, full port and reducing port Threaded, butt-welded or socket welded ends; design to BS5352

Specification (NPS)	R.P	-	1/2	3/4	1	1 1/4	1 1/2	2		
	F.P	1/4	3/8	1/2	3/4	1	1 1/4	1 1/2	2	
Face to face	L	Lift	73	73	80	100	114	145	160	-
		Swing	73	73	80	100	114	120	130	-
Height	H	Lift	50	50	53	64	80	84	102	-
		Swing	50	50	53	64	80	87	105	-
Height (angle dimension)	d	Lift	7	9	12	17.5	22.5	29	35	-
		Swing	8	9.5	13	17.5	24	29	36.5	-
Weight(Kg)		Lift	1.0	1.0	1.3	2.1	3.5	4.7	7.5	-
		Swing	1.1	1.1	1.2	2.2	3.1	4.2	6.5	-

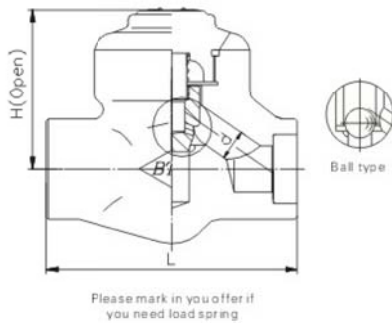

CL800 Welded bonnet, full port and reducing port Threaded, butt-welded or socket welded ends; design to BS5352

Specification (NPS)	R.P	1/2	3/4	1	1 1/4	1 1/2	2	2 1/2	
	F.P	1/4	3/8	1/2	3/4	1	1 1/4	1 1/2	
Face to face	L	73	73	80	100	114	145	160	-
Height	H	50	50	53	64	80	84	102	-
Height (angle dimension)	d	7	9	12	17.5	22.5	29	35	-
Weight(Kg)		1.0	1.0	1.3	2.1	3.5	4.7	7.5	-

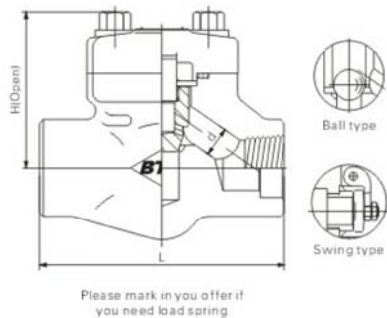

CL900-CL1500 Bolted bonnet, full port and reducing port Threaded, butt-welded or socket welded ends; design to BS5352

Specification (NPS)	R.P	-	1/2	3/4	1	1 1/4	1 1/2	2	
	F.P	1/4	3/8	1/2	3/4	1	1 1/4	1 1/2	
Face to face	L	Lift	100	100	114	145	160	172	-
		Swing	100	100	114	120	130	140	-
Height	H	Lift	64	64	80	84	102	118	-
		Swing	64	64	80	87	105	120	-
Height (angle dimension)	d	Lift	11	14.5	19	26	29	33	-
		Swing	13	13	17.5	24	29	36.5	-
Weight(Kg)		Lift	1.5	3.4	3.3	4.2	6.3	10.5	-
		Swing	1.5	3.4	3.3	4.2	5.0	8.5	-

Female threaded and socket welded globe valves

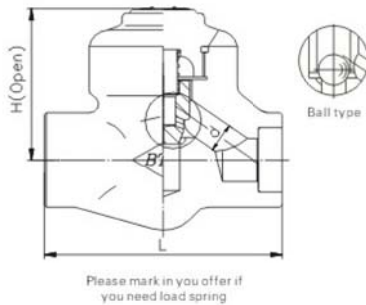

CL900-CL1500

Welded bonnet, full port and reducing port
Threaded, butt-welded or socket welded ends; design to BS5352

Specification (NPS)	R.P	1/2	3/4	1	1 1/4	1 1/2	2		
	F.P	1/4	3/8	1/2	3/4	1	1 1/4	1 1/2	2
Face to face	L	80	100	100	114	145	160	172	-
Height	H	53	64	64	80	84	102	118	-
Height (angle dimension)	d	7	11	14.5	19	26	29	33	-
Weight(Kg)		1.3	3.1	3.1	3.9	5.8	10.0	11.5	-

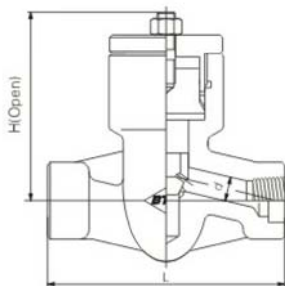

CL900-CL1500

Pressure seal bonnet, full port and reducing port
Threaded, butt-welded or socket welded ends; design to BS5352

Specification (NPS)	R.P	-	1/2	3/4	1	1 1/4	1 1/2	2	2 1/2	3
	F.P	1/4	3/8	1/2	3/4	1	1 1/4	1 1/2	2	2 1/2
Face to face	L	-	-	140	140	140	178	178	216	-
Height	H	-	-	130	130	130	190	190	213	-
Height (angle dimension)	d	-	-	13	16	19	25	27	36	-
Weight(Kg)		-	-	7.5	7.0	6.8	18.5	10.3	22	-

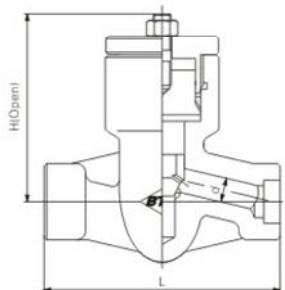

CL2500

Pressure seal bonnet, full port
Threaded, butt-welded or socket welded ends; design to ASME B16.34

Specification(NPS)	F.P	1/4	3/8	1/2	3/4	1	1 1/4	1 1/2	2
Face to face	L	-	-	186	186	186	232	232	279
Height	H	-	-	130	130	130	190	190	213
Height (angle dimension)	d	-	-	13	16	19	25	28	36
Weight(Kg)		-	-	11.8	11	10.5	23	26.4	39

Y type check valves/Y type pressure sealed check valves

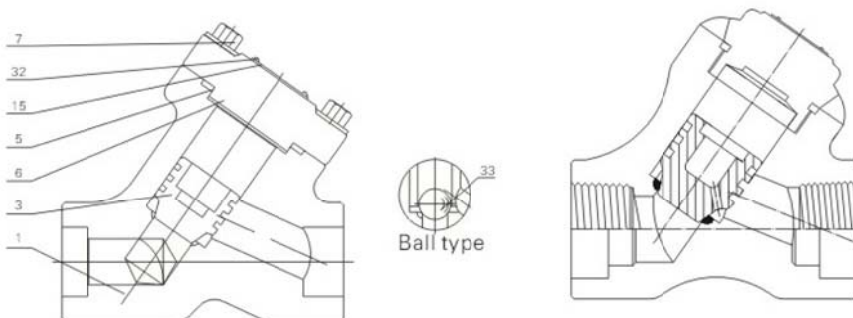

Please mark in you offer if you need load spring

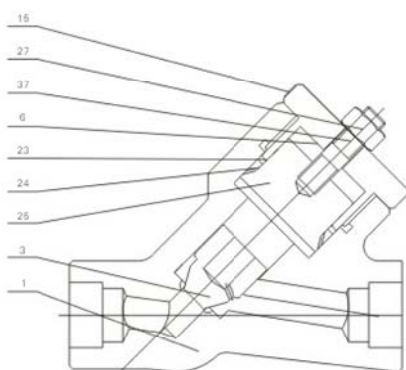

Application standards

- 1、 Design and manufacture conform to BS5352 MSS SP-118;
- 2、 Connection ends conform to:
 - 1)Socket welded ends conform to ANSI B16.11;JB/T1751
 - 2)Screw ends conform to ANSI B1.20.1; JB/T7306
 - 3)Butt-welded ends conform to ANSI B16.25;JB/T12224
 - 4)Flanged ends conform to ANSI B16.5; Jb79
- 3、 Test and inspection conform to: API 598; GB/T13927; JB/T9092
- 4、 Structure features: Bolted bonnet, Welded bonnet, A threaded and pressure seal bonnet; Y type and T type.
- 5、 Materials conform to ANSI/ASTM.
- 6、 Main materials: A105; LF2; F5; F11; F22; 304(L); 316(L); F347; F321; F51; Monel; 20 Alloy.

Carbon steel temperature-pressure rate

CL1500-3705 P.S.I @ 100° F
 CL2500-6170 P.S.I @ 100° F
 CL4500-1111P.S.I @ 100° F

Main part materials list

NO.	Part name	A105/F6a	A105/F6aHFS	LF2/304	F11/F6aHF	F304(L)/304(L)	F316(L)/316(L)	F51/F51
1	Body	A105	A105	LF2	F11	F304(L)	F316(L)	F51
3	Disc	410	410HF	304	410HF	304(L)	316(L)	F51
5	Gasket	304+ Flexible graphite	304+ Flexible graphite	304+ Flexible graphite	304+ Flexible graphite	304+ Flexible graphite	316+ Flexible graphite	316+ Flexible graphite
6	Bonnet	A105	A105	LF2	F11	F304(L)	F316(L)	F51
7	Bolt	B7	B7	L7	B16	B8(M)	B8(M)	B8M
15	Nameplate	AL	AL	AL	AL	AL	AL	AL
32	Revit	AL	AL	AL	AL	AL	AL	AL
33	Steel ball	430	430	304	STL	316(L)	316(L)	STL
1	Body	A105	A105+HF	LF2	F11+HF	F304(L)	F316(L)	F51
3	Disc	F6a	F6a	F304	F6aHF	F304(L)	F316(L)	F51
6	Bonnet	A105	A105	LF2	F11	F304(L)	F316(L)	F51
15	Nameplate	AL	AL	AL	AL	AL	AL	AL
23	Seal ring gasket	420	420	304	304	304(L)	316(L)	410
24	P.S. ring	304	304	304	304	316L	316L	316L
25	P.S. seat	F410	F410	F304	F410	F304	F316	F51
27	Lift nut	2H	2H	8	8	8(M)	8(M)	8M
37	Lift stud	B7	B7	L7	B16	B8(M)	B8(M)	B8M

Y type check valves

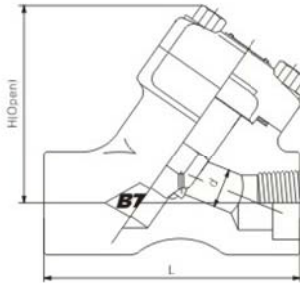

CL800

Welded bonnet, full port and reducing port
Threaded, butt-welded or socket welded ends; design to BS5352

Specification (NPS)	R.P	1/2	3/4	1	1 1/4	1 1/2	2	2 1/2	3	
	F.P	1/4	3/8	1/2	3/4	1	1 1/4	1 1/2	2	2 1/2
Face to face	L	98	98	98	111	140	140	155	170	
Height	H	70	70	70	100	110	120	120	150	
Height (angle dimension)	d	7	10	13	17.5	23	30	35	46	
Weight(Kg)		2.2	2.2	2.1	4.2	9	8.9	10	18.6	

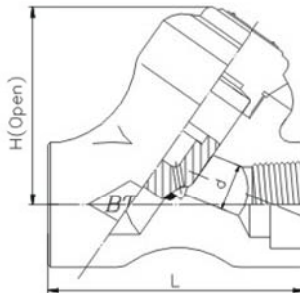

CL800

Welded bonnet, full port and reducing port
Threaded, butt-welded or socket welded ends; design to BS5352

Specification (NPS)	R.P	1/2	3/4	1	1 1/4	1 1/2	2	2 1/2	3	
	F.P	1/4	3/8	1/2	3/4	1	1 1/4	1 1/2	2	2 1/2
Face to face	L	79	79	79	90	118	155	155	175	
Height	H	60	60	60	90	100	105	105	135	
Height (angle dimension)	d	7	9	13	17.5	22.5	29.5	35	44	
Weight(Kg)		1.8	1.8	2.0	3.5	8.0	8.0	12	16	

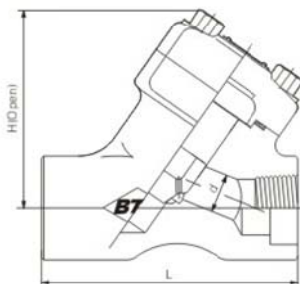

CL900-CL1500

Bolted bonnet, full port
Threaded, butt-welded or socket welded ends; design to BS5352

Specification(NPS)	F.P	3/8	1/2	3/4	1	1 1/4	1 1/2	2
Face to face	L	98	111	111	140	140	155	170
Height	H	70	70	100	110	110	120	150
Height (angle dimension)	d	9	12	15	20	28	32	40
Weight(Kg)		2.1	4.2	9	8.9	10	18.6	20

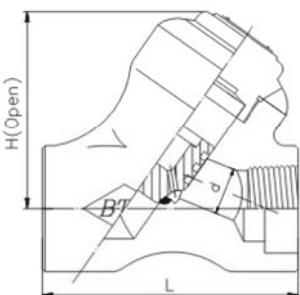

CL900-CL1500

Bolted bonnet, full port
Threaded, butt-welded or socket welded ends; design to BS5352

Specification(NPS)	F.P	3/8	1/2	3/4	1	1 1/4	1 1/2	2
Face to face	L	79	90	118	155	155	175	200
Height	H	66	90	100	105	105	135	135
Height (angle dimension)	d	9	13	17.5	22.5	29.5	35	44
Weight(Kg)		2.0	3.5	3.5	8.0	12	12	18

Y type check valves

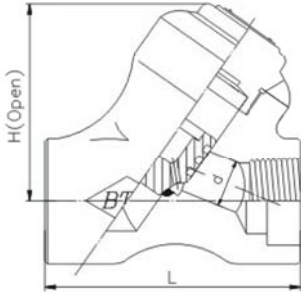

CL2500

Welded bonnet, full port
Threaded, butt-welded or socket welded ends; design to ASME B16.34

Specification(NPS)	F.P	3/8	1/2	3/4	1	1 1/4	1 1/2	2
Face to face	L	186	186	186	186	232	232	310
Height	H	115	115	120	150	150	150	160
Height (angle dimension)	d	9	11	14	19	25	28	35
Weight(Kg)		11.2	11.5	10.6	10.8	25	22	39

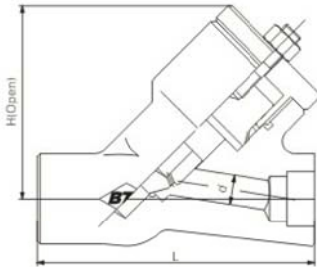

CL2500

Pressure seal, bolted bonnet, full port
Threaded, butt-welded or socket welded ends; design to ASME B16.34

Specification(NPS)	F.P	3/8	1/2	3/4	1	1 1/4	1 1/2	2
Face to face	L	186	186	186	186	232	232	310
Height	H	233	233	233	233	256	256	330
Height (angle dimension)	d	9	11	14	19	25	28	35
Weight(Kg)		11.2	11.5	10.6	10.8	25	22	39

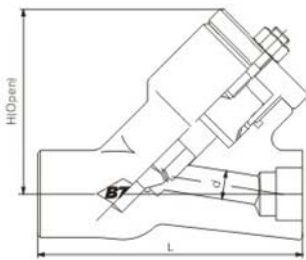

CL4500

Pressure seal, bolted bonnet, full port
Threaded, butt-welded or socket welded ends; design to ASME B16.34

Specification(NPS)	F.P	3/8	1/2	3/4	1	1 1/4	1 1/2	2
Face to face	L	200	200	200	200	250	250	330
Height	H	140	140	140	140	160	160	180
Height (angle dimension)	d	9	11	11	15	20	26	28
Weight(Kg)		20	20	20	20	28	28	45

Flange and butt-welded check valves

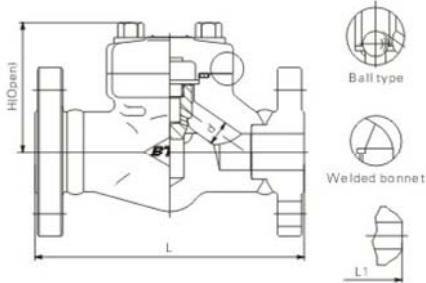

CL150-300-600

Bolted bonnet, full port
Flange-welded or butt-welded ends; design to BS5352

Specification(NPS)	R.P	1/4	3/8	1/2	3/4	1	1 1/4	1 1/2	2	
Face to face	CL150	L(RF) L1(BW)	-	-	108	118	127	140	165	203
	CL300		-	-	153	178	203	216	229	267
	CL600		-	-	165	191	216	229	241	292
Height	CL150	-	-	50	53	64	80	84	102	
	CL300/600	H	-	-	50	53	64	80	84	102
Height(angle dimension)	d	-	-	9	12	17.5	22.5	29	35	
Weight (Kg)	CL150	RF	-	-	3.3	3.4	4.7	8.2	11.5	12.9
		BW	-	-	2.9	3.0	3.6	7.8	10.2	11.6
	CL300	RF	-	-	3.4	3.5	5.6	8.6	11.7	13.8
		BW	-	-	3.0	3.0	4.8	7.6	10.3	12.0
	CL600	RF	-	-	3.5	3.6	6.1	10.4	15.6	24.5
		BW	-	-	3.0	3.1	5.5	9.2	13.8	21.5

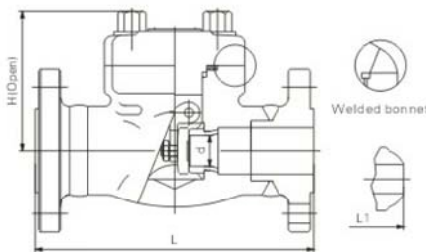

CL150-300-600

Bolted bonnet, full port
Flange-welded or butt-welded ends; design to BS5352

Specification(NPS)	R.P	1/4	3/8	1/2	3/4	1	1 1/4	1 1/2	2	
Face to face	CL150	L(RF) L1(BW)	-	-	108	118	127	140	165	203
	CL300		-	-	153	178	203	216	229	267
	CL600		-	-	165	191	216	229	241	292
Height	CL150	-	-	50	53	64	80	84	102	
	CL300/600	H	-	-	50	53	64	80	84	102
Height(angle dimension)	d	-	-	9.5	13	17.5	24	29	36.5	
Weight (Kg)	CL150	RF	-	-	3.2	3.6	4.6	9.2	10.2	11.1
		BW	-	-	2.8	3.0	4.0	8.5	8.9	10.0
	CL300	RF	-	-	3.7	4.8	5.5	9.6	11.3	17.8
		BW	-	-	3.2	4.3	4.8	8.6	10.2	16.2
	CL600	RF	-	-	4.0	4.8	6.0	9.5	15.6	24.5
		BW	-	-	3.4	4.0	5.1	8.8	14.8	22.5

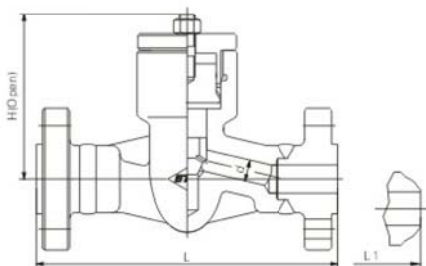

CL900-CL1500

Pressure seal, bolted bonnet, full port and reducing port
Flange-welded or butt-welded ends; design to BS5352

Specification(NPS)	F.P	3/8	1/2	3/4	1	1 1/4	1 1/2	2
Face to face	L(RF), L1(BW)		216	229	254	280	305	268
	L(RTJ)		216	229	254	280	305	371
Height	H		117	117	117	152	152	195
Height (angle dimension)	d		13	16	19	25	27	36
Weight(Kg)			10.5	11.9	13.9	19.9	26.9	32.5

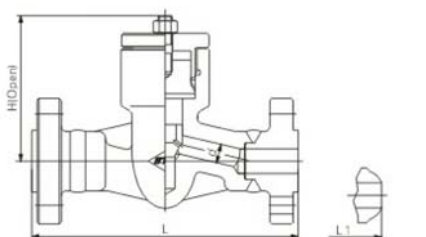

CL2500

Pressure seal, bolted bonnet, full port
Flange-welded or butt-welded ends; design to ASME B16.34

Specification(NPS)	F.P	3/8	1/2	3/4	1	1 1/4	1 1/2	2
Face to face	L(RF), L1(BW)		264	273	308	349	384	450
	L(RTJ)		264	273	308	352	387	454
Height	H		117	117	117	152	152	195
Height (angle dimension)	d		13	16	19	25	28	36
Weight(Kg)			12.6	14.9	16.5	24.8	30	35